

# Sundström

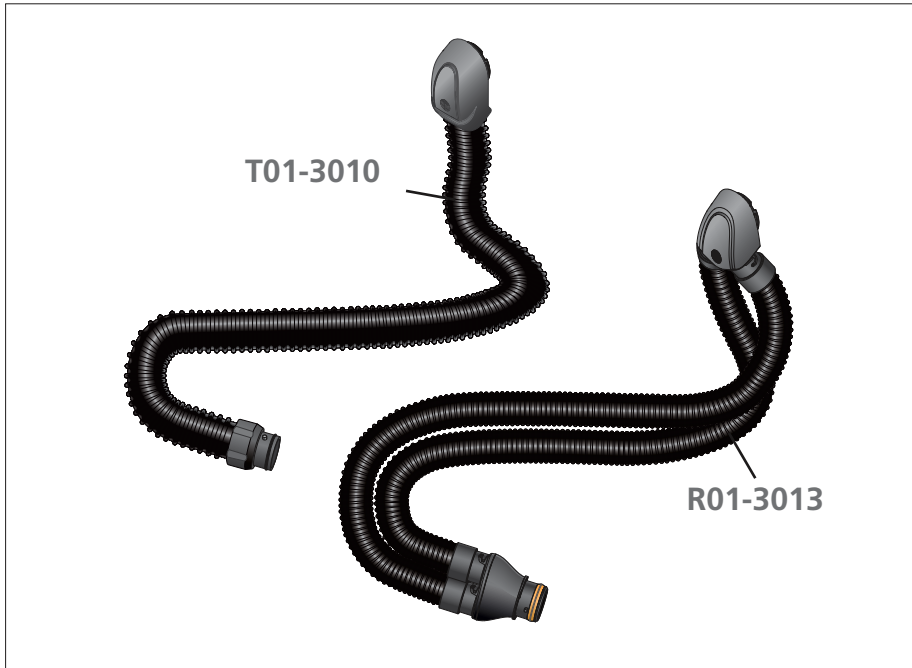

## SR 951

Breathing hose for SR 900, T01-3010

## SR 952

Breathing hose for SR 900, R01-3013

**Sundstrom Safety Inc.**

143 Maple St. Warwick, RI 02888

Office: 1-401-434-7300 Toll Free: 1-877-SUNDSTROM Fax: 1-401-434-8300

info@srsafety.com www.srsafety.com

# SR 951 / SR 952

SR 900	SR 905	SR 951	①
		SR 952	②
	SR 500	SR 951	③
		SR 952	④

## SR 951 - T01-3010

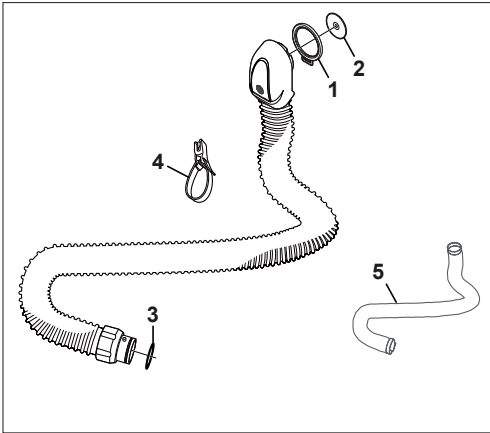

1. R01-3004
2. R01-3010
3. R06-0202
4. T01-3007
5. T06-4016

	R01-3004	12 M
	R01-3010	12 M
	R06-0202	12 M

## SR 952 - R01-3013

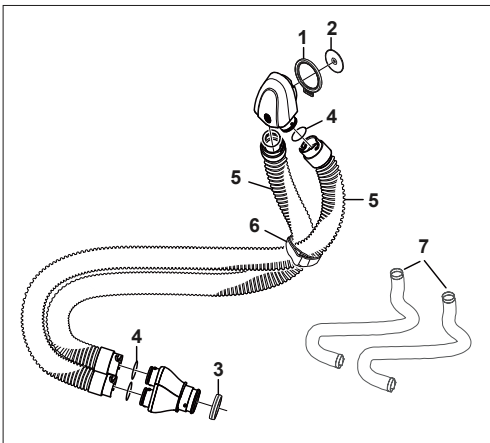

1. R01-3004
2. R01-3010
3. R01-3011
4. R01-3008 (x4)
5. R01-3007 (x1)
6. R01-3012
7. T01-3004 (x1)

	R01-3004	12 M
	R01-3010	12 M
	R01-3011	12 M
	R01-3008	12 M

# SR 951 / SR 952

1

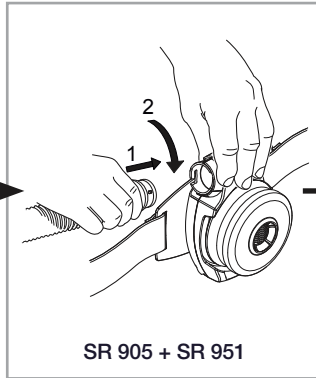
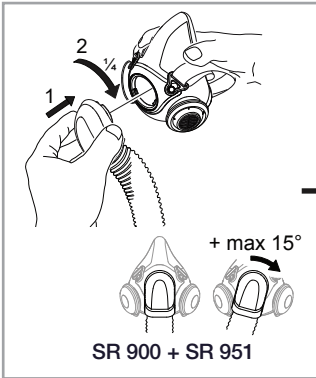

2

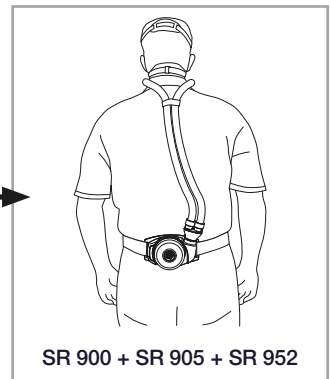
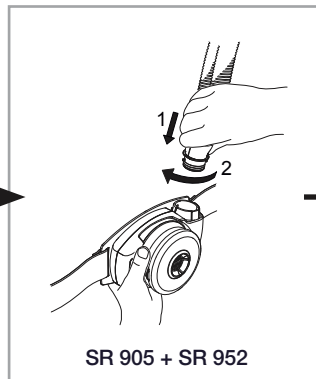
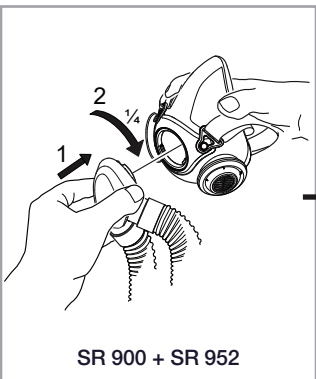

3

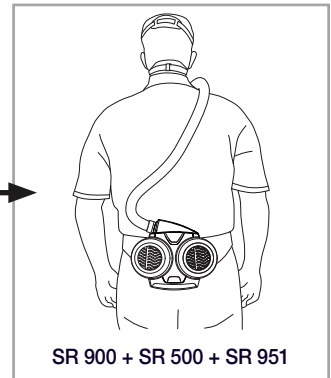
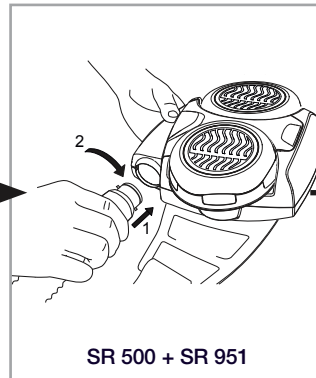
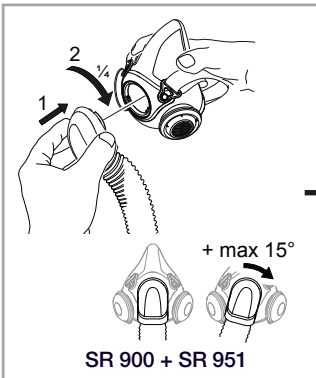

4

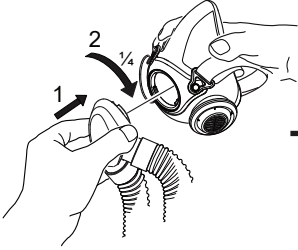

SR 900 + SR 952

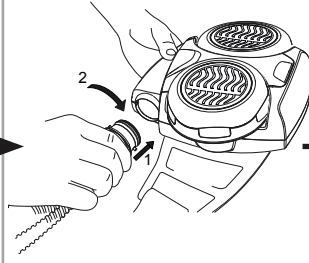

SR 500 + SR 952

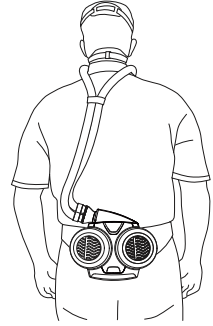

SR 900 + SR 500 + SR 952

**Sundström** 